

Diamond Drilling 2016-1.1

UK

OBP Brno, spol. s r.o.
Hvezdoslavova 53b
627 00 Brno
Tel: +420 548 214 046
E-mail: info@obpbrno.cz
www.obpbrno.cz

marcr**ist**
Experience the difference



1979-2016
37
YEARS
Innovation
& Technology

Diamond Drilling 2016-1.1

www.marcris.com

Marcryst Money Back Guarantee



We trust in our products and their performance, we would like you to do the same. That's why we offer the outstanding Marcryst Brand Guarantee:

Test any Marcryst products for 30 days, put them through the toughest tasks. If you are not totally satisfied with our products, you get your money back. Guaranteed!

Always here for you

Need Technical Support?

Contact Marcryst and ask for «Technical Support» for any questions or problems related to diamonds.

When you ring our Technical Support line you will automatically speak to experts with a combined diamond knowledge of over 113 years*.

If we cannot solve your problem over the telephone we will normally have an engineer on your site within 48 hours.



Technical Support Helpline:
UK: +44 (0) 1302 893 253



Like us on Facebook

Marcryst International Limited

Follow us on Twitter

Marcryst Tools



Keep up-to-date whilst on the go! Check out our road shows and event dates. We're likely to be holding product demonstrations at a store near you!

We'd love to hear your feedback! Let us know what you think of our products and services.



Marcryst Homepage

Can't find the information you're looking for in our catalogue? Have a look online! Take advantage of our Product-Selector-Tool to help you choose the best product for your application. www.marcryst.com







Marcryst YouTube Channel

Keep up to date with our latest product films. Packed with useful application tips, and product features and benefits.

www.youtube.com/MarcrystTools



Detailed Diamond Cores Overview

	PC850	DCU750X	DCU350	CCU850X	CCW850X
Performance	Turbo Diamond Percussion Core	Fast Universal	Universal	Fast Universal Combi	Pipe drilling
Available Ø	Ø38 - 200mm	Ø22 - 162mm	Ø28 - 152mm	Ø22 - 200mm	Ø102 - 257mm
Thread	½" BSP(M)	½" BSP(F)	½" BSP(F)	½" BSP(F)	1¼" UNC(F)
Length	165mm	400 or 165 mm	165mm	400 or 165mm	165mm
Wet / Dry use				 	 
Application	Hand held	Hand held	Hand held	Hand held	Hand held
Performance	Extreme speed	Fast Universal	Dry core	Fast Universal Combi	Specifically developed for pipe drilling
Ideal machine power	800 – 1500 Watt	800 – 1500 Watt	800 – 1500 Watt	800 – 1500 Watt	1500 – 2500 Watt
Materials drilled					
Concrete products	✓	✓	✓	✓	✓
Unreinforced concrete	✓	✓	✓	✓	✓
Standard reinforced concrete	✓	✗	✗	✓	✓
Lightly reinforced concrete	✓	✗	✗	✗	✓
Heavily reinforced concrete	✗	✗	✗	✗	✗
Extremely reinforced concrete	✗	✗	✗	✗	✗
Brick	✓	✓	✓	✓	✓
Block	✓	✓	✓	✓	✓
Engineering bricks	✓	✓	✓	✓	✓
Concrete bricks	✓	✓	✓	✓	✓
Natural stone	✓	✓	✓	✓	✓
Lintels	✓	✓	✓	✓	✓
Kalksandstein	✓	✓	✓	✓	✓
Poroton	✓	✓	✓	✓	✓
Composite brick & concrete	✓	✗	✗	✗	✓
Concrete pipes	✓	✗	✗	✗	✓
Asphalt	✗	✗	✗	✗	✗
Bitumen	✗	✗	✗	✗	✗
Extremely abrasive materials	✗	✗	✗	✗	✗

Detailed Diamond Cores Overview

CCW850X	WCU850X	WCU350	WCU850X-F	WF850X	WA850X
Universal Combi	Wet	Wet	Wet Ringsegment	Extreme Reinforcing	Asphalt
Ø38 - 200mm	Ø52 - 350mm	Ø52 - 250mm	Ø12 - 40mm	Special sizes and extra lengths are available on request	Special sizes and extra lengths are available on request
1 1/4" UNC(F)	1 1/4" UNC(F)	1 1/4" UNC(F)	1/2" BSP(M)	1 1/4" UNC(F)	1 1/4" UNC(F)
350mm	450mm	450mm	200mm / 350mm	450 mm	450 mm
					
Hand held and rig mounted	Rig mounted	Rig mounted	Hand held and rig mounted	Rig mounted	Rig mounted
Quick	Quick and long life	Quick and long life	Quick and long life	Extreme speed and long life	Extreme long life
1500 – 2500 Watt	1500 – 3000 Watt	1500 – 3000 Watt	1500 – 3000 Watt	2500 – 3500 Watt	1500 – 3000 Watt
✓	✓	✓	✓	✗	✗
✓	✓	✓	✓	✗	✗
✓	✓	✓	✓	✗	✗
✓	✓	✓	✓	✗	✗
✗	✓	✓	✓	✓	✗
✗	✗	✗	✗	✓	✗
✓	✓	✓	✓	✗	✗
✓	✓	✓	✓	✗	✗
✓	✓	✓	✓	✗	✗
✓	✓	✓	✓	✗	✗
✓	✓	✓	✓	✗	✗
✓	✓	✓	✓	✗	✗
✓	✓	✓	✓	✗	✗
✓	✓	✓	✓	✗	✗
✓	✓	✓	✓	✗	✗
✓	✓	✓	✓	✗	✗
✓	✗	✗	✗	✗	✗
✗	✓	✓	✓	✗	✓
✗	✗	✗	✗	✗	✓
✗	✗	✗	✗	✗	✓

⁽¹⁾Segment heights can vary. Usable segments heights are on average 1.5-2.5mm less than the specified segment height. Marcryst reserves the right to change segment heights and specification without prior notification. ⁽²⁾Product recommendations may vary according to user and/or machine and/or materials. All prices exclude VAT.

PC850 Diamond Percussion Core dry, hand held



Perfect holes between Ø38mm - Ø200mm

A must for every Plumbing, Heating and Electrical Specialist

WORLD FIRST
1st

- The revolutionary new dry diamond core
- Drills the hardest materials that were previously incapable of being drilled dry
 - fast
 - efficient
 - without drilling residue!



PC850 Extreme Speed Diamond Percussion Core 1/2" BSP (F)



Why buy me:

- Fastest dry core, ever!
- Dry percussion diamond core 1/2" BSP (F)
- Lowest cost-per-hole
- Extreme speed
- Extreme long life



Concrete products



Non-reinforced concrete



Bricks



London bricks



Concrete pipes



Building materials



Concrete & stone



Calcareous sandstone



Poroton



Natural stone

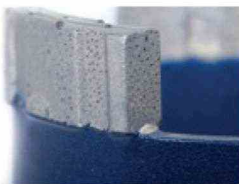
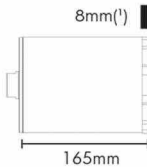

Part Number	Diameter	Length
245.165.0038	38 mm	165 mm
245.165.0048	48 mm	165 mm
245.165.0052	52 mm	165 mm
245.165.0065	65 mm	165 mm
245.165.0078	78 mm	165 mm
245.165.0082	82 mm	165 mm
245.165.0102	102 mm	165 mm
245.165.0107	107 mm	165 mm
245.165.0117	117 mm	165 mm
245.165.0127	127 mm	165 mm
245.165.0132	132 mm	165 mm
245.165.0152	152 mm	165 mm
245.165.0162	162 mm	165 mm
245.165.0181	181 mm	165 mm
245.165.0200	200 mm	165 mm

⁽¹⁾Segment heights can vary. Usable segments heights are on average 1.5-2.5mm less than the specified segment height. Marcris reserves the right to change segment heights and specification without prior notification. ⁽²⁾Product recommendations may vary according to user and/or machine and/or materials. All prices exclude VAT.

Diamond Cores wet and dry, hand held

PC850 3 Core Toolbox



Contents include:

- Ø38mm Percussion Core
- Ø52mm Percussion Core
- Ø117mm Percussion Core
- 200mm Pilot Drill
- Drift Key
- 3 Jaw Chuck Short Adaptor 1/2" BSP(M)
- Extension rod
- Plus Aluminium carry case

Part Number	Description
245.512.0001	3 Diamond Core toolbox. Contents include: Ø38mm, Ø52mm, Ø117mm percussion cores and accessories

CCU850X Fast Universal Combi 1/2" BSP (F)



Why buy me:

- For wet and dry use
- Extreme speed
- Universal application
- Drills a wide variety of building materials and concrete products



Concrete products



Poroton



Bricks



London bricks



Concrete pipes

Part Number	Diameter	Length
249.122.0022	22 mm	400 mm
249.122.0028	28 mm	400 mm
249.122.0032	32 mm	400 mm
249.122.0038	38 mm	165 mm
249.122.0048	48 mm	165 mm
249.122.0052	52 mm	165 mm
249.122.0060	60 mm	165 mm
249.122.0065	65 mm	165 mm
249.122.0072	72 mm	165 mm
249.122.0078	78 mm	165 mm
249.122.0082	82 mm	165 mm
249.122.0102	91 mm	165 mm
249.122.0082	102 mm	165 mm
249.122.0107	107 mm	165 mm
249.122.0112	112 mm	165 mm
249.122.0117	117 mm	165 mm
249.122.0127	127 mm	165 mm
249.122.0132	132 mm	165 mm
249.122.0152	152 mm	165 mm
249.122.0162	162 mm	165 mm
249.122.0181	181 mm	165 mm
249.122.0200	200 mm	165 mm

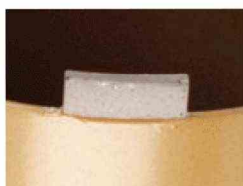
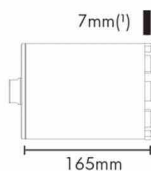

⁽¹⁾Segment heights can vary. Usable segment heights are on average 1.5-2.5mm less than the specified segment height. Marcris reserves the right to change segment heights and specification without prior notification. ⁽²⁾Product recommendations may vary according to user and/or machine and/or materials. All prices exclude VAT.

Diamond Cores dry, hand held

DCU750X Fast Universal 1/2" BSP (F)



Why buy me:

- Extreme speed
- Universal application
- Drills a wide variety of building materials and concrete products
- Outstanding value for money



Concrete products



Poroton



Bricks



London bricks



Concrete pipes

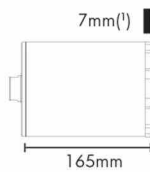

Part Number	Diameter	Length
252.122.0022	22 mm	400 mm
252.122.0028	28 mm	400 mm
252.122.0032	32 mm	400 mm
252.122.0038	38 mm	165 mm
252.122.0048	48 mm	165 mm
252.122.0052	52 mm	165 mm
252.122.0060	60 mm	165 mm
252.122.0065	65 mm	165 mm
252.122.0072	72 mm	165 mm
252.122.0078	78 mm	165 mm
252.122.0082	82 mm	165 mm
252.122.0091	91 mm	165 mm
252.122.0107	107 mm	165 mm
252.122.0117	117 mm	165 mm
252.122.0127	127 mm	165 mm
252.122.0132	132 mm	165 mm
252.122.0152	152 mm	165 mm
252.122.0162	162 mm	165 mm

Diamond Cores dry and wet, hand held

DCU 350 Universal 1/2" BSP(F)

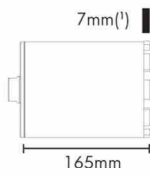

Concrete products



Poroton



Bricks



London bricks



Concrete pipes

Part Number	Diameter	Length
240.400.0028	28 mm	400 mm
240.165.0038	38 mm	165 mm
240.165.0052	52 mm	165 mm
240.165.0065	65 mm	165 mm
240.165.0078	78 mm	165 mm
240.165.0082	82 mm	165 mm
240.165.0107	107 mm	165 mm
240.165.0117	117 mm	165 mm
240.165.0127	127 mm	165 mm
240.165.0132	132 mm	165 mm
240.165.0152	152 mm	165 mm

DCU 350 3 Piece Core Kit



Contents include:

- Ø38mm diamond core
- Ø52mm diamond core
- Ø117mm diamond core

5 drilling accessories:

- Drift Key
- SDS adaptor
- 3 jaw chuck adaptor
- Extension bar
- Pilot Drill

Part Number	Description
240.500.0002	Diamond Core toolbox. Contents include: Ø38mm, Ø52mm and Ø117mm cores and accessories

⁽¹⁾Segment heights can vary. Usable segment heights are on average 1.5-2.5mm less than the specified segment height. Marcris reserves the right to change segment heights and specification without prior notification. ⁽²⁾Product recommendations may vary according to user and/or machine and/or materials. All prices exclude VAT.

CCW 850X Pipe Drilling 1 1/4" UNC(F)

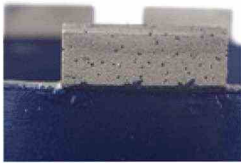
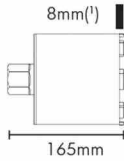

Why buy me:

- Extreme speed • Extreme Long life



Concrete pipes

Part Number	Diameter	Length
286.142.0102	102 mm	165 mm
286.142.0138	138 mm	165 mm
286.142.0152	152 mm	165 mm
286.142.0162	162 mm	165 mm
286.142.0186	186 mm	165 mm
286.142.0200	200 mm	165 mm
286.142.0212	212 mm	165 mm
286.142.0225	225 mm	165 mm
286.142.0257	257 mm	165 mm

CCW 850X Universal-Combi 1 1/4" UNC(F)

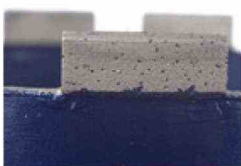
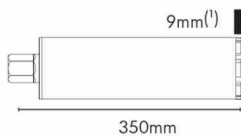

Why buy me:

- Wet and dry combi diamond core 1 1/4 " UNC (F) • Drills wet or dry • Extreme speed
- Perfect for use where slurry must be avoided



Concrete products



Natural stone



Concrete lintels



Calcareous sandstone



Poroton

Part Number	Diameter	Length
262.142.0038	38 mm	350 mm
262.142.0048	48 mm	350 mm
262.142.0052	52 mm	350 mm
262.142.0060	60 mm	350 mm
262.142.0065	65 mm	350 mm
262.142.0072	72 mm	350 mm
262.142.0078	78 mm	350 mm
262.142.0082	82 mm	350 mm
262.142.0091	91 mm	350 mm
262.142.0102	102 mm	350 mm
262.142.0112	112 mm	350 mm
262.142.0127	127 mm	350 mm
262.142.0132	132 mm	350 mm
262.142.0152	152 mm	350 mm
262.142.0162	162 mm	350 mm
262.142.0182	182 mm	350 mm
262.142.0200	200 mm	350 mm

⁽¹⁾Segment heights can vary. Usable segments heights are on average 1.5-2.5mm less than the specified segment height. Marcryst reserves the right to change segment heights and specification without prior notification. ⁽²⁾Product recommendations may vary according to user and/or machine and/or materials. All prices exclude VAT.

WCU 850X-F Wet Ringsegment 1/2" BSP(M)



Why buy me:

- Extreme speed • Extreme long life • Lowest cost-per-hole • 9mm⁽¹⁾ Ringsegment



Building materials



Concrete products



Reinforced concrete



Natural stone

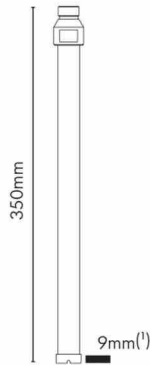

9mm⁽¹⁾ Ringsegment

Part Number	Diameter	Length
260.001.0012	12 mm	200 mm
260.001.0014	14 mm	200 mm
260.001.0016	16 mm	200 mm
260.001.0018	18 mm	200 mm
260.001.0020	20 mm	350 mm
260.001.0022	22 mm	350 mm
260.001.0024	24 mm	350 mm
260.001.0025	25 mm	350 mm
260.001.0028	28 mm	350 mm
260.001.0030	30 mm	350 mm
260.001.0032	32 mm	350 mm
260.001.0035	35 mm	350 mm
260.001.0040	40 mm	350 mm

⁽¹⁾Segment heights can vary. Usable segments heights are on average 1.5-2.5mm less than the specified segment height. Marcris reserves the right to change segment heights and specification without prior notification. ⁽²⁾Product recommendations may vary according to user and/or machine and/or materials. All prices exclude VAT.

Diamond Cores wet, rig mounted

WCU 850X Wet 1 1/4" UNC(F)



Why buy me:

- Extreme speed • Extreme long life • Extreme lowest cost-per-hole
- 9mm(1) roof-top segment • Perfect for highly reinforced concrete



Building materials



Concrete products



Highly reinforced Concrete

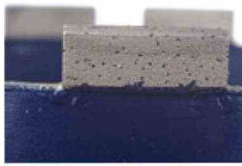
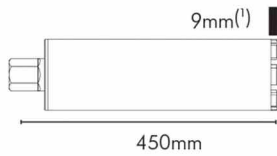

9mm(1) Roof-top segment

Part Number	Diameter	Length
284.001.0052	52 mm	450 mm
284.001.0060	60 mm	450 mm
284.001.0065	65 mm	450 mm
284.001.0078	78 mm	450 mm
284.001.0082	82 mm	450 mm
284.001.0102	102 mm	450 mm
284.001.0112	112 mm	450 mm
284.001.0122	122 mm	450 mm
284.001.0127	127 mm	450 mm
284.001.0132	132 mm	450 mm
284.001.0138	138 mm	450 mm
284.001.0152	152 mm	450 mm
284.001.0162	162 mm	450 mm
284.001.0182	182 mm	450 mm
284.001.0200	200 mm	450 mm
284.001.0212	212 mm	450 mm
284.001.0225	225 mm	450 mm
284.001.0250	250 mm	450 mm
284.001.0300	300 mm	450 mm
284.001.0350	350 mm	450 mm

Special sizes and extra lengths are available on request

WCU350 Wet 1 1/4" UNC(F)



Building materials



Concrete products



Highly reinforced Concrete

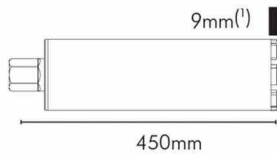

Part Number	Diameter	Length
287.001.0052	52 mm	450 mm
287.001.0065	65 mm	450 mm
287.001.0082	82 mm	450 mm
287.001.0102	102 mm	450 mm
287.001.0112	112 mm	450 mm
287.001.0122	122 mm	450 mm
287.001.0132	127 mm	450 mm
287.001.0152	152 mm	450 mm
287.001.0162	162 mm	450 mm
287.001.0182	182 mm	450 mm
287.001.0200	200 mm	450 mm
287.001.0225	225 mm	450 mm
287.001.0250	250 mm	450 mm

⁽¹⁾Segment heights can vary. Usable segment heights are on average 1.5-2.5mm less than the specified segment height. Marcris reserves the right to change segment heights and specification without prior notification. ⁽²⁾Product recommendations may vary according to user and/or machine and/or materials. All prices exclude VAT.

Diamond Cores wet, rig mounted

WF 850X Extreme Reinforcing 1 1/4" UNC(F)



Why buy me:

- Special diameters and sizes available • Special lengths
- Special adapter fittings available upon request



Extreme reinforcing



Extreme flint



450mm

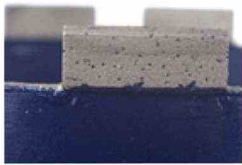

Part Number	Diameter	Length
-------------	----------	--------

Special sizes and extra lengths are available on request

WA 850X Asphalt and Refractories 1 1/4" UNC(F)



Why buy me:

- Special diameters and sizes available • Special lengths
- Special adapter fittings available upon request



Asphalt & Refractories



Asphalt



Asphalt



450mm

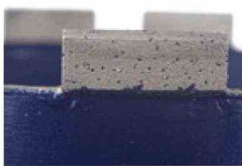

Part Number	Diameter	Length
-------------	----------	--------

Special sizes and extra lengths are available on request

⁽¹⁾Segment heights can vary. Usable segment heights are on average 1.5-2.5mm less than the specified segment height. Marcris reserves the right to change segment heights and specification without prior notification. ⁽²⁾Product recommendations may vary according to user and/or machine and/or materials. All prices exclude VAT.

Dust free drilling

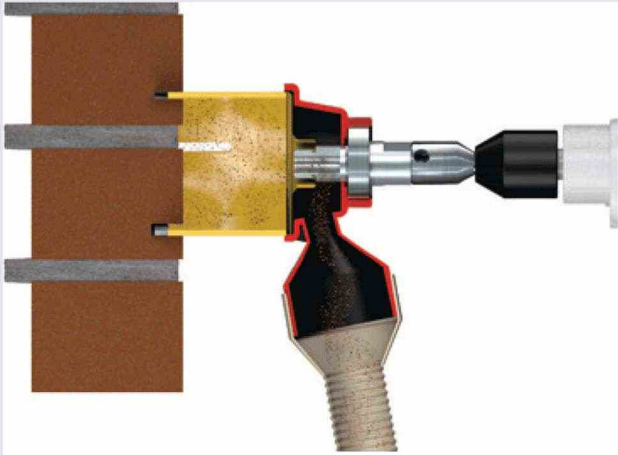

Dust free drilling with the Dust Extraction Unit*

- Minimise the risks associated with dust exposure
- Increases core life by up to 100%
- Increases drilling speed by up to 100%
- Healthier & cleaner
- Less dust and debris to clean up
- Suitable for use with all

Marcris 850 Range Diamond Cores

* Part Number 320.101.0055. See page 17.

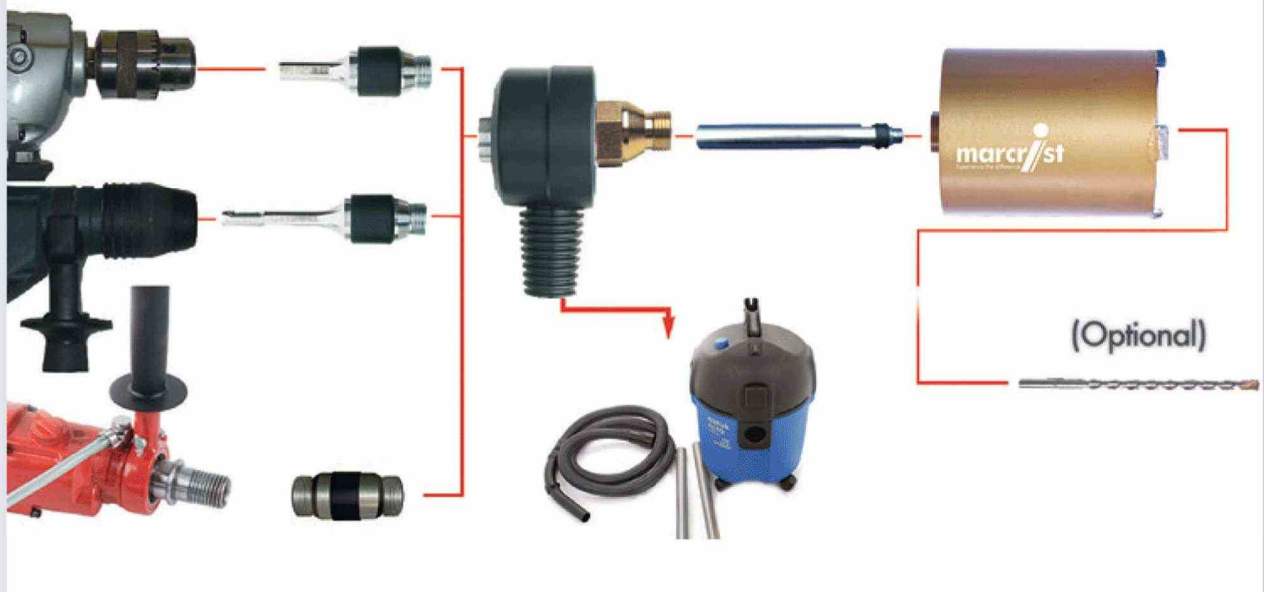





Diamond Cores hand held and rig mounted



Accessories for 1/2" short version Diamond Cores

	Part Number	Description
	340.101.0002	1/2" x 20 UNF to 1/2" BSP (M) Adapter
	340.101.0005	3 Jaw Chuck Adapter to 1/2" BSP (M)
	340.101.0006	SDS to 1/2" BSP (M) Adapter
	340.101.0042	Hilti DD100 to 1/2" BSP (M) Adapter
	340.101.0023	1/2" BSP (M) to 1/2" BSP (M) Adapter
	330.101.0006	250mm extension 1/2" BSP (F-M)
	310.101.0013	225mm A-Taper Pilot Drill
	350.101.0002	Drift key
	340.101.0111	Guide Rod for Core Extraction 165mm
	320.101.0050	Dust Extraction Unit 1/2" BSP
	310.101.0015	Pilot Drill 300mm A-Taper for Dust Extraction Unit
	330.101.0001	150mm Extension 1/2" BSP (F-M) for Dust Extraction Unit
	330.101.0002	300mm Extension 1/2" BSP (F-M) for Dust Extraction Unit
	340.101.0115	300mm Guide Rod

Accessories for 1 1/4" long version Diamond Cores

	Part Number	Description
	330.101.0004	200mm extension 1 1/4" UNC (F)
	330.101.0005	300mm extension 1 1/4" UNC (F)
	340.101.0210	Combi Core Guide Rod 350mm, Ø16mm inc drift key
	340.101.0211	Combi Core Guide Rod 450mm, Ø16mm inc drift key
	320.101.0055	Dust Extraction Unit 1 1/4" UNC

Adapter for wet Diamond Cores

	Part Number	Description
	340.100.0047	1/2" BSP(M) to 1 1/4" UNC(M)
	340.100.0044	DD100, DD130, DCM1 & DD80 to 1/2" BSP(F) to Hilti Bayonet (converts standard 1/2" BSP(M) wet core to fit to Hilti bayonet system)
	340.101.0059	DDBU UNC 1 1/4" to 1 1/4" Adaptor wet core for use with Hilti Bayonet System

⁽¹⁾Segment heights can vary. Usable segments heights are on average 1.5-2.5mm less than the specified segment height. Marcryst reserves the right to change segment heights and specification without prior notification. ⁽²⁾Product recommendations may vary according to user and/or machine and/or materials. All prices exclude VAT.

Diamond Drilling - Marcryst makes it easy

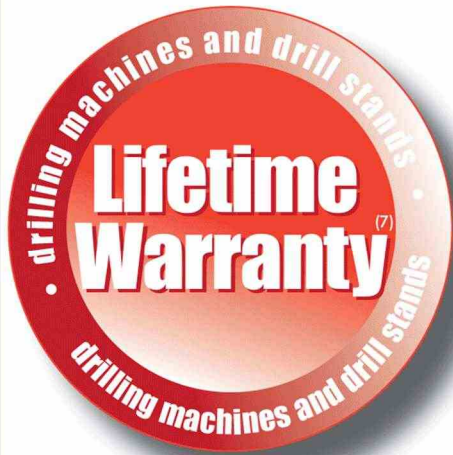

Lifetime Warranty for Marcryst Machines⁽⁷⁾

If your Machine becomes defective due to faulty materials or workmanship, we guarantee to replace all defective parts free of charge or, at our discretion, replace the unit free of charge⁽⁷⁾.





No Segment Loss Guaranteed⁽⁶⁾

Conventional core drills regularly lose segments. We are confident that Marcris core drills are the best in the world because they drill faster, last longer and do not lose segments.

Even with our unique quality, however, it is still possible to damage the core and/or tear off part of the steel tube or even the segment. With Marcris cores this does not need to be a disaster because we will repair the core drill for you - totally free!⁽⁶⁾



⁽⁶⁾ Terms & Conditions available on page 31. ⁽⁷⁾ Terms & Conditions available on page 31

DDM1 Compact Lightweight Professional Diamond Drill

- 2-speed gearbox for hand held drilling
- Diamond percussion drill with percussion, safety clutch and electronic override protection
- Lightweight
- Drills extremely quickly
- Easy and comfortable to use
- Life-long manufacturer guarantee

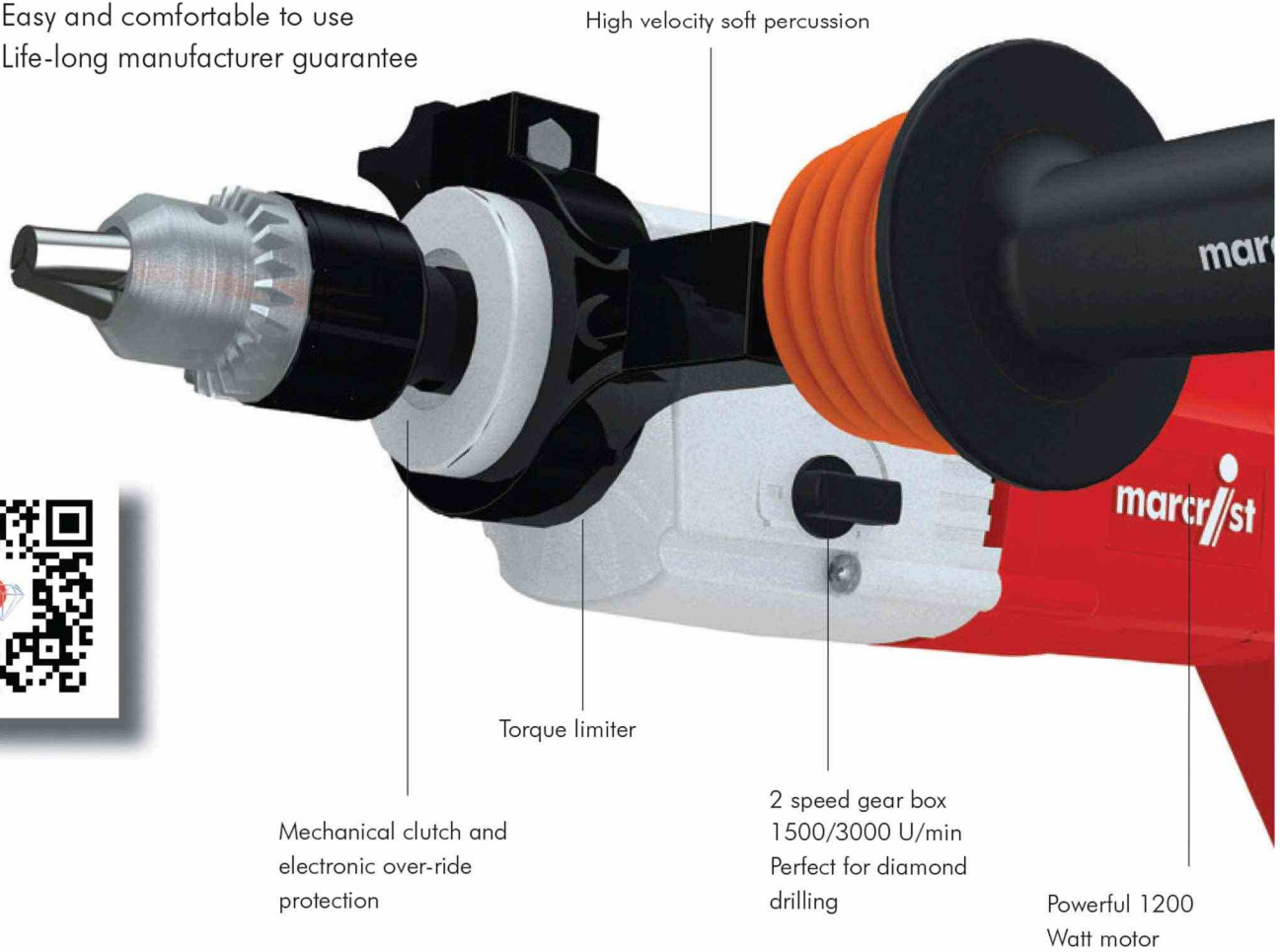

Perfect drilling with the **PC850** diamond Percussion Cores

Diamond Drilling dry, hand held



CE

Performance Data **DDM1**

Voltage	110V/230V
Concrete	Ø10 - 132 mm
Masonry	Ø10 - 152 mm
Power	1200 Watt
2 Speed gearbox	0 - 1500 / 0 - 3000 rpm
Gearing	High velocity soft percussion
Mechanical Safety	Mechanical safety clutch
Electronic Safety	Torque limiter
Housing	☐
Vibration	Anti-Vibrations AVG
Weight	4.0 kg

Part Number

7740.001.003	230V (with EU plug)
7740.001.002	110V (with GB plug)
7740.001.001	230V (with GB plug)

⁽¹⁾Segment heights can vary. Usable segments heights are on average 1.5-2.5mm less than the specified segment height. Marcrst reserves the right to change segment heights and specification without prior notification. ⁽²⁾Product recommendations may vary according to user and/or machine and/or materials. All prices exclude VAT.

DDM3 The Super Professional

- 3 speed gearbox for hand held and rig mounted drilling
- The professional's choice of diamond drilling machine
- Life-long manufacturer guarantee

Flexibility
Integral water feed for dry and wet drilling.
Switch between wet and dry drilling at the flick of a switch

Total Safety
Integral clutch protects machine and operator

Total flexibility accepts all cores 1/2" & 1 1/4"

3 speed gearbox

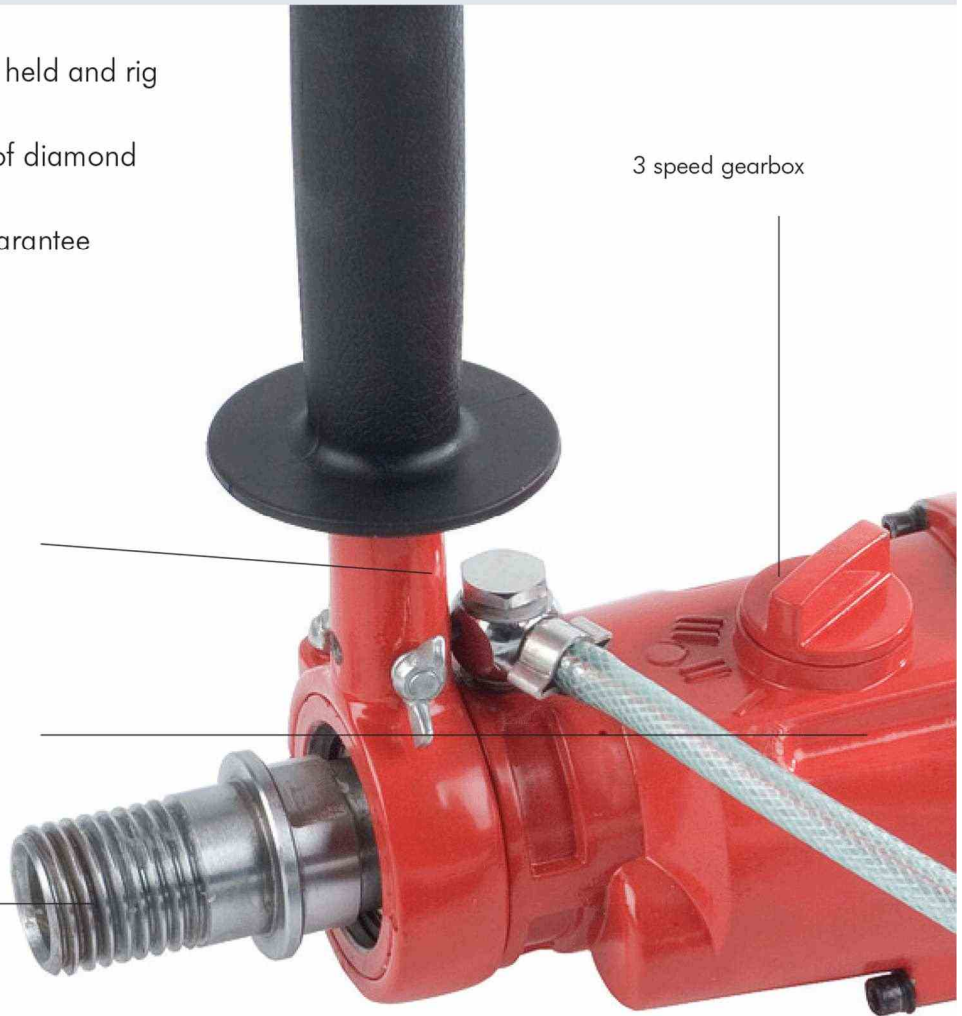

Ultimate Safety
In-line PRCD protection switches off electrical current within milli-seconds (240V only)

Diamond Drilling wet and dry, hand held and rig mounted

Durability

Break resistant metal housing for durability and long life



Total Power
Powerful 1500 Watt
performance



Performance Data **DDM3**

Voltage	110V/230V
Concrete	Ø10 - Ø152mm
Masonry	Ø10 - Ø200mm
Power	1500 Watt
3 speed gearbox	950/1800/3450 rpm
Gearbox	3 speed gearbox
Mechanical Safety	Safety clutch
Electronic Safety	PRCD
Housing	Metal
Waterfeed	Intergrated
NettoWeight	5,8 kg
Gross weight	10,82 kg

Part Number

7750.001.003	230V (with EU plug)
7750.001.002	110V (with GB plug)
7750.001.001	230V (with GB plug)

⁽¹⁾Segment heights can vary. Usable segments heights are on average 1.5-2.5mm less than the specified segment height. Marcryst reserves the right to change segment heights and specification without prior notification. ⁽²⁾Product recommendations may vary according to user and/or machine and/or materials. All prices exclude VAT.

DDM4 The Heavyweight

- 2 gear speeds for rig drilling
- The professional rig mounted drilling machine
- Life long manufacturer warranty

Total Safety
Mechanical safety clutch protects machine and operator

Total Flexibility
Accepts all cores 1/2" and 1 1/4"

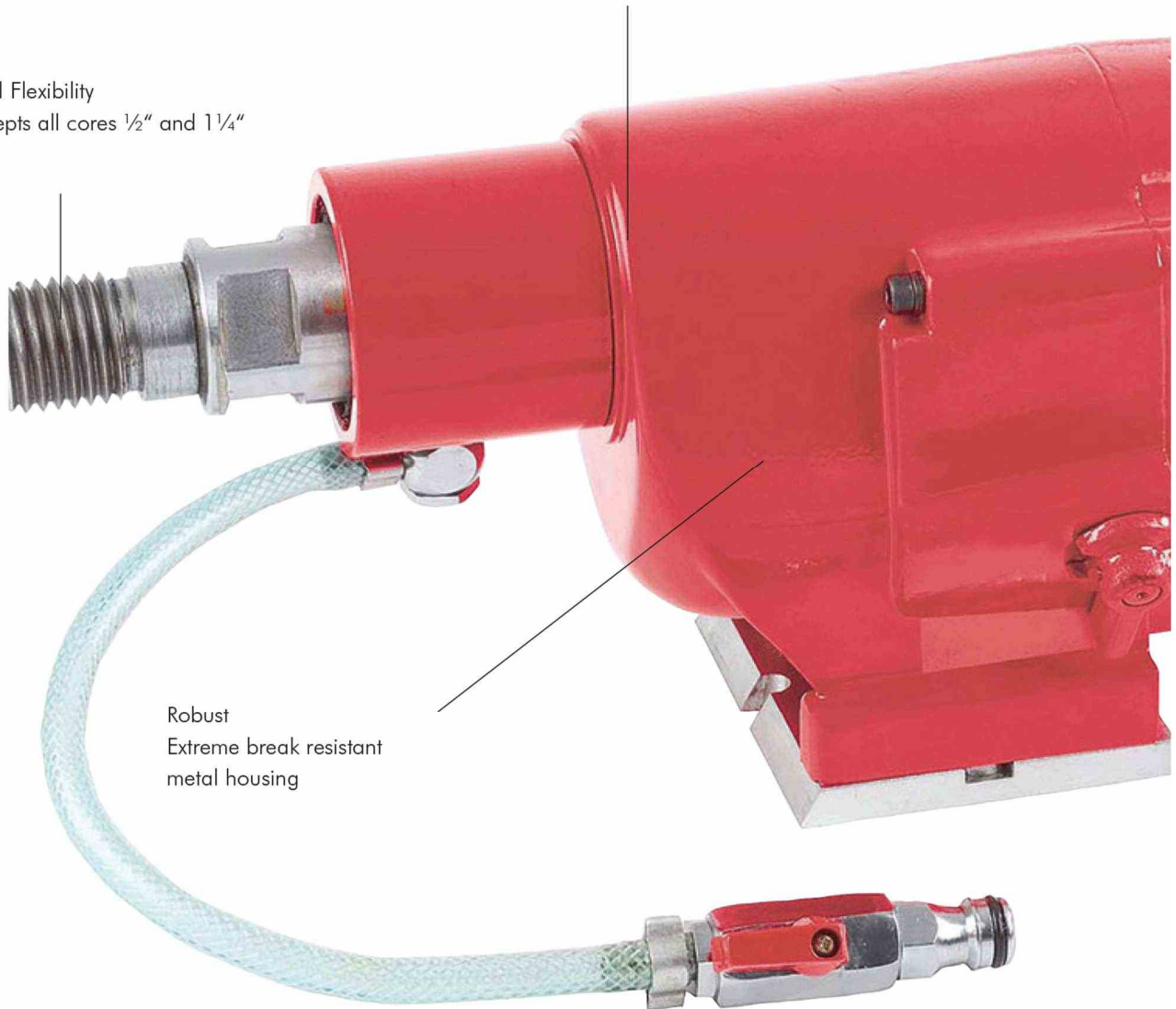

Robust
Extreme break resistant
metal housing

Ultimate Safety
In-line PRCD protection switches off
electrical current (240V only)

Diamond Drilling wet and dry, rig mounted

Sealed for life
Sealed grease bath gearbox for extreme life

Total Power
Powerful 2450 watt
performance

marcrist

CE

Performance Data **DDM 4**

Voltage	110V/230V
Concrete	Ø250 mm
Masonry	Ø350 mm
Power	2450 Watt
2 Speed gearbox	460/900 rpm
Gearing	2 speed gearbox
Mechanical Safety	Safety clutch
Electronic Safety	PRCD
Housing	Metal
Waterfeed	Intergrated
Nett weight	13,0 kg
Gross weight	15,5 kg

Part Number

7760.001.003	230V (with EU plug)
7760.001.002	110V (with GB plug)

⁽¹⁾Segment heights can vary. Usable segments heights are on average 1.5-2.5mm less than the specified segment height. Marcris reserves the right to change segment heights and specification without prior notification. ⁽²⁾Product recommendations may vary according to user and/or machine and/or materials. All prices exclude VAT.

DS150 Compact Mini Drill Stand for DDM3

- Ultra light weight
- Ultra compact



Performance Data DS 150

Height	840mm
Width	170mm
Weight	9,6 kg
Capacity	Ø150mm

Part Number

7800.501.001 **DS150 Compact mini drill stand**



DS250 Alu Compact Drill Stand for DDM3/DDM4

- 90° tiltable for angle drilling from 0 – 90°
- Precision aluminium construction



⁽¹⁾Segment heights can vary. Usable segments heights are on average 1.5-2.5mm less than the specified segment height. Marcryst reserves the right to change segment heights and specification without prior notification. ⁽²⁾Product recommendations may vary according to user and/or machine and/or materials. All prices exclude VAT.

DS350 Alu Drill Stand for DDM4

Ø350mm Capacity

- 90° tiltable for angle drilling from 0 – 90°
- Precision aluminium construction

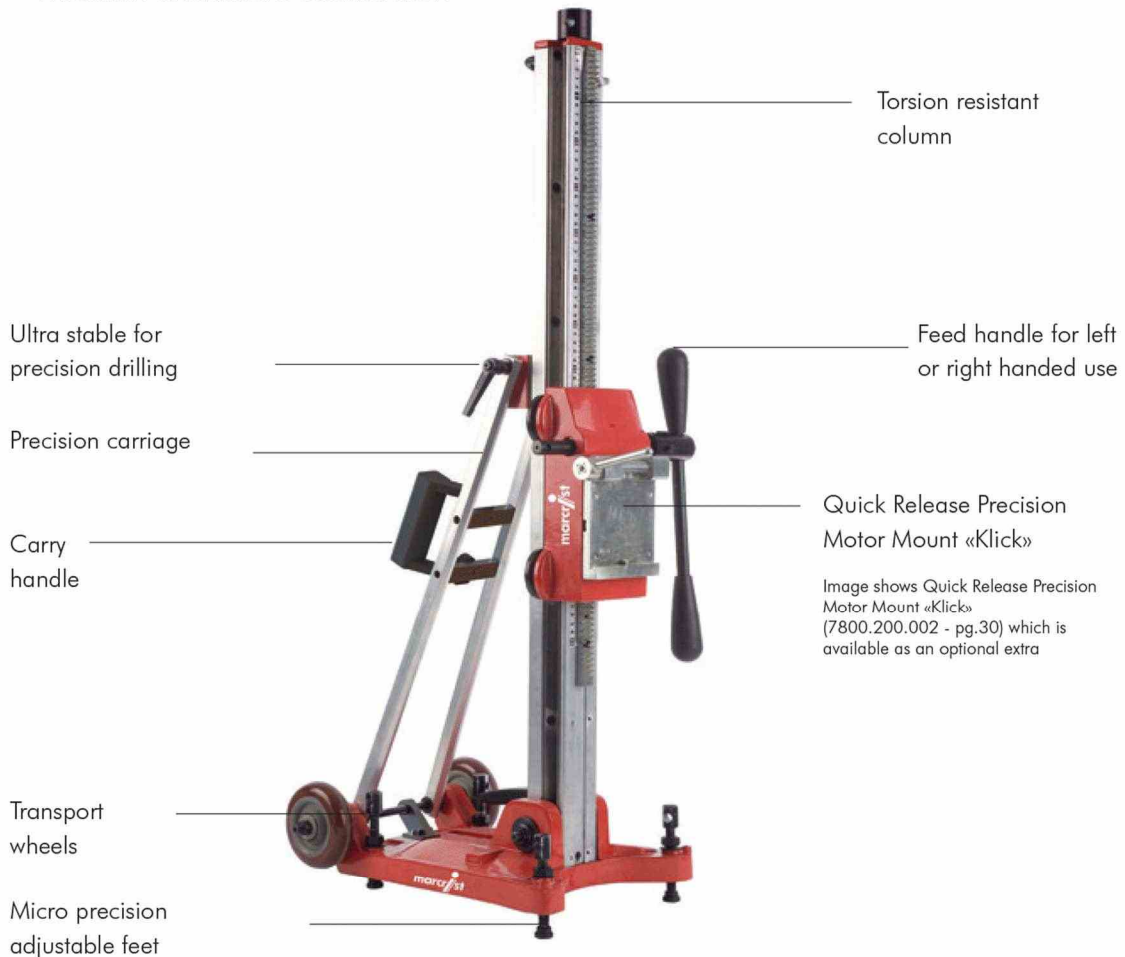

CE

Performance Data DS350

Height	1000 mm
Width	270 mm
Weight	17,0 kg
Capacity	Ø350 mm

Part Number

7800.501.003	DS350 Alu drill stand with transport wheels and vacuum foot
--------------	--



Compact Kit: **DDM3** and **DS150** rig drilling

- Ultra lightweight **DS 150** - Ø150mm capacity Complete with motor mounting collar
- **DDM3** - 3 speed drilling motor - 950/1800/3450 rpm
Capacity: Concrete - Ø152mm, Masonry - Ø152mm (Ø200mm DDM3 hand-held)
- Includes transport case for **DDM3** and spanner set



CE



Includes transport case



Includes spanner set

Compact Kit **DDM3** und **DS150**

Contents include:

- **DDM3** The super professional diamond drilling machine
- **DS150** Compact drill stand
- Spanner set

Part Number

3999.101.056	Compact Kit: DDM3 230V (with EU plug) and DS150
3999.101.057	Compact Kit: DDM3 110V (with GB plug) and DS150
3999.101.090	Compact Kit: DDM3 230V (with GB plug) and DS150

⁽¹⁾Segment heights can vary. Usable segments heights are on average 1.5-2.5mm less than the specified segment height. Marcryst reserves the right to change segment heights and specification without prior notification. ⁽²⁾Product recommendations may vary according to user and/or machine and/or materials. All prices exclude VAT.

Midi Kit: **DDM3** and **DS250** rig drilling

- **DS250** - Ø250mm capacity
Complete with precision motor mounting collar, transport wheels, vacuum and bolt down foot
- **DDM3** - 3 speed drilling motor - 950/1800/3450 rpm
Capacity: Concrete - Ø152mm, Masonry - Ø200mm
- Includes transport case for **DDM3** and spanner set



CE

Midi Kit **DDM3** und **DS250**

Contents include:

- **DDM3** The super professional diamond drilling machine
- **DS250** Compact drill stand
- Spanner set

Part Number

3999.101.058	Midi-Set: DDM3 230V (with EU plug) and DS250 Titan
3999.101.059	Midi-Set: DDM3 110V (with GB plug) and DS250 Titan
3999.101.091	Midi-Set: DDM3 230V (with GB plug) and DS250 Titan



Includes transport case



Includes spanner set

Maxi Kit: **DDM4** and **DS250** rig drilling

- **DS250** - Ø250mm capacity
Complete with transport wheels, vacuum, and bolt down foot
- **DDM4** - 2 speed drilling motor - 460/900 rpm
Capacity: Concrete - Ø250mm, Masonry - Ø350mm
- Includes spanner set



CE



DDM4 The heavy weight



Includes spanner set

Maxi Kit **DDM4** und **DS250**

Contents include:

- **DDM4** The heavyweight diamond drilling machine
- **DS250** Alu drill stand
- Spanner set

Part Number

3999.101.060

Maxi Kit: **DDM4** 230V (with EU plug)
and **DS250** Titan

3999.101.061

Maxi Kit: **DDM4** 110V (with GB plug)
and **DS250** Titan

⁽¹⁾Segment heights can vary. Usable segments heights are on average 1.5-2.5mm less than the specified segment height. Marcris reserves the right to change segment heights and specification without prior notification. ⁽²⁾Product recommendations may vary according to user and/or machine and/or materials. All prices exclude VAT.

Diamond Drilling rig drilling

Diamond Drilling Accessories **DDM3/4** and **DS 150/250/350**

	Part Number	Description
	7800.001.011	Water Pressure Bottle 11L. With 2 meter hose and connect coupling. Safety pressure release valve. Provides constant water flow for wet drilling when used with DDM2 , DDM3 or DDM4
	7800.001.001	Combination Anchor Set for Concrete and Brick. For DS 150 and DS250 for securing the rig either vertically or horizontally to a concrete/brick drilling surface. Includes 3 re-usable anchors
	7800.001.002	Replacement Anchors. For use with above (re-usable) 5pcs.
	7800.001.014	Spanner Set (Wet Drilling). For removing cores from the DDM4 1 x 36mm (DDM4), 1 x 41mm 11/4"
	7800.001.004	Water Collection System includes seals For DS 150 , DS250 & DS350 to collect waste water when wet drilling Ø10 - 150mm
	7800.001.005	Water Collection System includes seals For DS 150 , DS250 & DS350 to collect waste water when wet drilling Ø10 - 250mm
	7800.001.006	Replacement Top Seals. For use with above Ø10 - 150mm (set of 3)
	7800.001.007	Replacement Top Seals. For use with above Ø10 - 250mm (set of 3)
	7800.001.012	Replacement Bottom Seals Ø150mm (set of 3)
	7800.001.013	Replacement Bottom Seals Ø120mm (set of 3)
	7800.200.003	Precision Motor Mount DS250 For easy mounting of DDM2/DDM3 to DS 250 and DS350
	7800.200.002	Quick Release Precision Motor Mount «Klick» DS250 and DS350 For quick release mounting of DDM4 to the DS250 and DS350
	7800.100.005	Vacuum Set. DS250 Vacuum Seal/Vacuum Plug For securing DS250 with vacuum suction, to surface
	7800.001.010	Replacement vacuum seals for DS250 For use with above (set of 3)
	7800.100.002	Vacuum Pump. Provides vacuum suction for DS250 and DS350 when used in conjunction with vacuum set (7800.100.005 above) 110V (GB plug)
	7800.100.001	Vacuum Pump. Provides vacuum suction for DS250 and DS350 when used in conjunction with vacuum set (7800.100.005 above) 230V (GB plug)

Money Back Guarantee

Marcris is the world's first diamond company to not only promise but guarantee satisfaction.

The Marcris money back guarantee is aimed at ensuring your total satisfaction with Marcris 850, 750 and 350 range products.

The Marcris money back guarantee is subject to the following terms and conditions: If you are not satisfied with the performance of the product you have the right to return it to your dealer within 30 days, together with proof of purchase. If you are not satisfied this could only be, in our opinion, because your machine is faulty, worn or because you are using the product for an application for which it has not been designed. The guarantee does not cover fair wear and tear.

It is therefore in your interest and in that of your safety, for an expert to examine the product and, if needed, recommend alternatives or identify the need for repairs to your machinery or flanges, etc. For this to happen your dealer will post the product to Marcris at your expense. Our expert will examine the product within 24 hours of its receipt and contact you with his findings and, where necessary, advise. If you agree with this advice, we will send our recommended alternative product to your distributor immediately, free of charge and with no delivery costs. If you are not satisfied with our opinion and do not wish to have a replacement product sent to you, we will immediately arrange for your dealer to refund your full purchase price.

No Segment Loss Guarantee - Free Core Repairs

Conventional core drills regularly lose segments. We are confident that Marcris core drills are the best in the world because they drill faster, last longer and do not lose segments. Even with our unique quality, however, it is still possible to damage the core and/or tear off part of the steel tube or even the segment. With Marcris cores this does not need to be a disaster because we will repair the core drill for you - totally free. Free repair is subject to the following procedure and conditions: Take the Marcris 850 or 750 core to your Marcris dealer. Providing that your core still has a minimum of 4mm* of segment left, he will send it to us for repair and charge you for the postage costs. Marcris will repair your core at no charge whatsoever. We will even fit the lost segments for free.

Having repaired the core, which normally takes 48 hours from its receipt, we will return it to your distributor. If, upon examination of the core, we find that your application may call for a different core, or that your machine - drill rig, spindle, etc., or method of use may need examination, our experts will call you to offer advice or a site visit.

*If the segments have worn to less than 4mm the core body will have worn to the point where it cannot be repaired and no refund can be offered.

Lifetime Warranty for Marcris Machines

If your Machine becomes defective due to faulty materials or workmanship, we guarantee to replace all defective parts free of charge or, at our discretion, replace the unit free of charge provided that:

- Proof of purchase is produced and the machine has been registered.
- The defect is not due to normal wear and tear.
- The product has not been misused and has been serviced regularly.
- Professional quality consumables, capable of drilling hard materials, have been used exclusively.
- Repairs have not been attempted by unauthorised persons.

⁽¹⁾Segment heights can vary. Usable segment heights are on average 1.5-2.5mm less than the specified segment height. Marcris reserves the right to change segment heights and specification without prior notification. ⁽²⁾Product recommendations may vary according to user and/or machine and/or materials. All prices exclude VAT.

